

C) Caution

The Foldable Softbox is mainly made of cloth and is flammable. Please keep the softbox away from fire or high temperature objects.



EHA - Series FOLDABLE SOFTBOX ON FLASH GUNS Instruction Manual

D) Compatible Flashgun List

Bower SFD35	Olympus FL36 / FL36R
Canon 430EX, 430EX II	Olympus G40, FL40
Canon 580EX II, 580EX, 550EX	Olympus FL50, FL50R
Cosmos D728AF, DS328AFZ	Panasonic DMW-FL360
Cosmos D35AF	Panasonic DMW-FL500
FalconEyes DMF880,	Phoenix DZBIS-112CII
FalconEyes DSL880AFZ	ProMaster 7500DX
FalconEyes DPT386AZF	Sony F42AM, F56AM
FalconEyes 3600P	Sony F32X, HVL-F58AM
Metz 36AF4N, 40AF4N,	Sunpak 444D
Metz 44AF4C, 48AF-1, 58AF-1	Sunpak 4000AF
Nikon SB600 / SB800	Sunpak 888F2 THYRISTER
Nikon SB 27, 28	Sigma EF530 DG ST
Nikon SB-900	Sigma EF530 DG Super
Nikon SB24, 25, 26	Sigma EF430, EF500 DG ST
Nissin Di866, Nissin Di622	Vivitar DF400MZ, DF283, DF383
	Vivitar 285HV, DF340Z

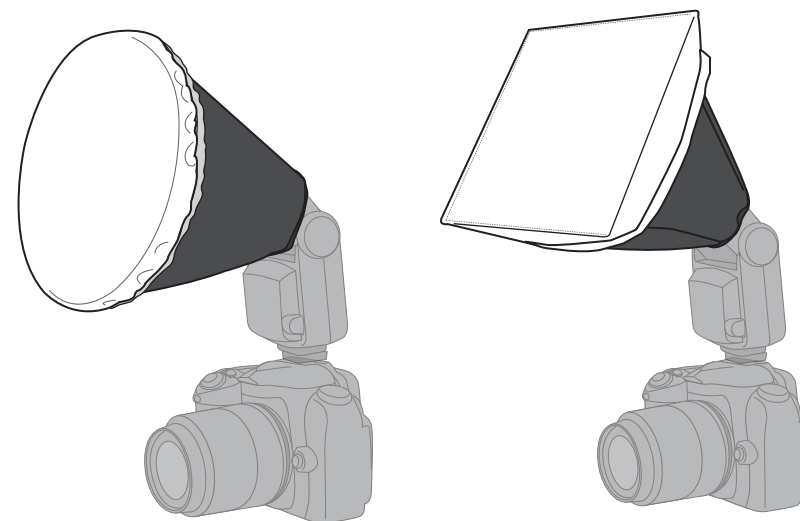

EHA-CB15

EHA-SB1520

Thank you for purchasing FalconEyes' products.

**For further details of our related products, please contact your local distributor or visit our webpage at www.falconeyes.com.hk
Thank you.**

**Please read this manual carefully before using this product.
Falcon Eyes Limited**

A) Part list

EHA-SB1520 (15 x 20cm)



Softbox body x 1
Velcro x 1
Diffuser x 1

EHA-CB15 (Ø 15cm)



Softbox body x 1
Velcro x 1
Diffuser x 1

B) Installation

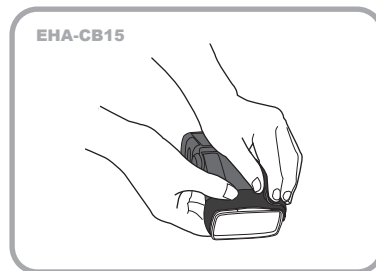
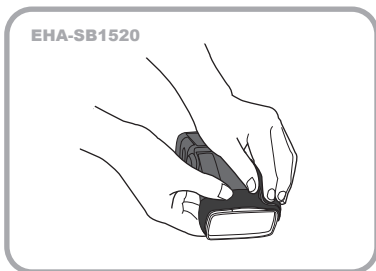

1 Wrap the Velcro around the flash gun.

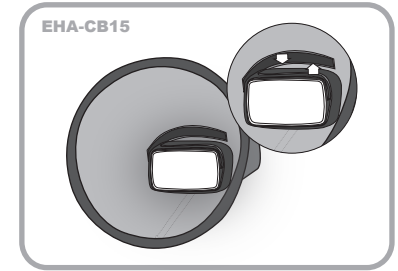
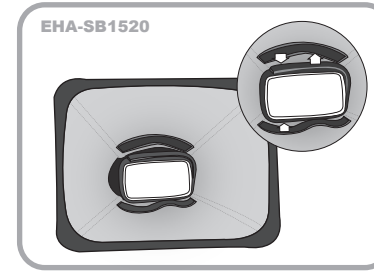

2 Place the softbox body onto the flash gun and align the softbox body with the Velcro.

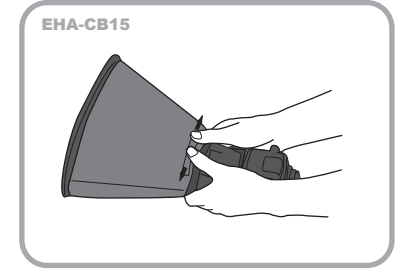
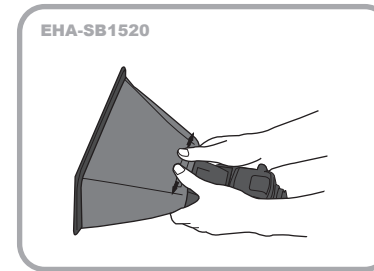

3 Stick the softbox cloth on the Velcro tightly.

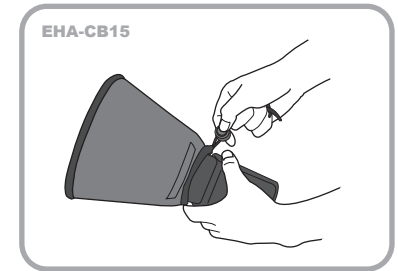
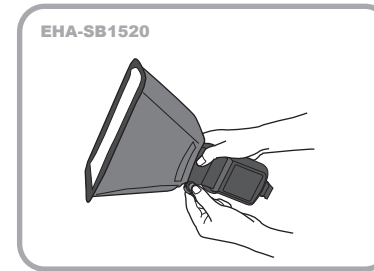

4 Pull the string and lock.

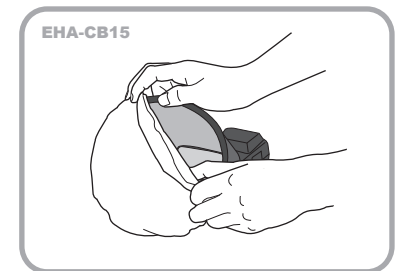
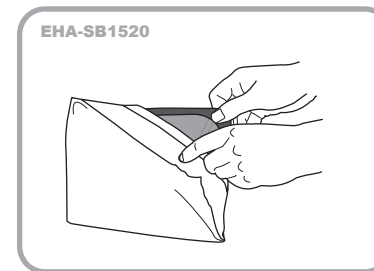

5 Cover the diffuser on the softbox body.